

NTools PWW 400

Pneumatic cartridge gun with a telescopic piston for 290ml and 310ml cartridges and 400ml sachets

APP No. 110505N

NTools PWW 400

Pneumatic gun purposed for aluminium cartridge and sachet including one-component products and silicone used during works related to manufacture and installation, of door and window, as well as repairs or motor vehicles.

It delivers an original texture (shell related) of sprayed sealing for joints and welded seams. With the gun you can deliver also dashed plaster texture and apply with high precision any sealing available in cartridge volume max. 310 ml or sachet 400 ml.

Spraying or application of one-component products and silicones.

Smooth regulation of speed and dosing amount

Compatible with cartridges and sachets.

max 310 ml

max 400 ml

NTools PWW 400

Pneumatic cartridge gun with a telescopic piston for 290ml and 310ml cartridges and 400ml sachets

Design:

NTools

1 Removable nozzles

for multiple spray textures

2 Compact construction

casing for optimal work comfort.

3 Telescopic piston

for precise application.

4 Differential pressure valve

is responsible for immediate stopping of the mass injection

5 2 precise regulators

for application rate and volume control atomization – product consistence and volume, as well as qty of applied particles.

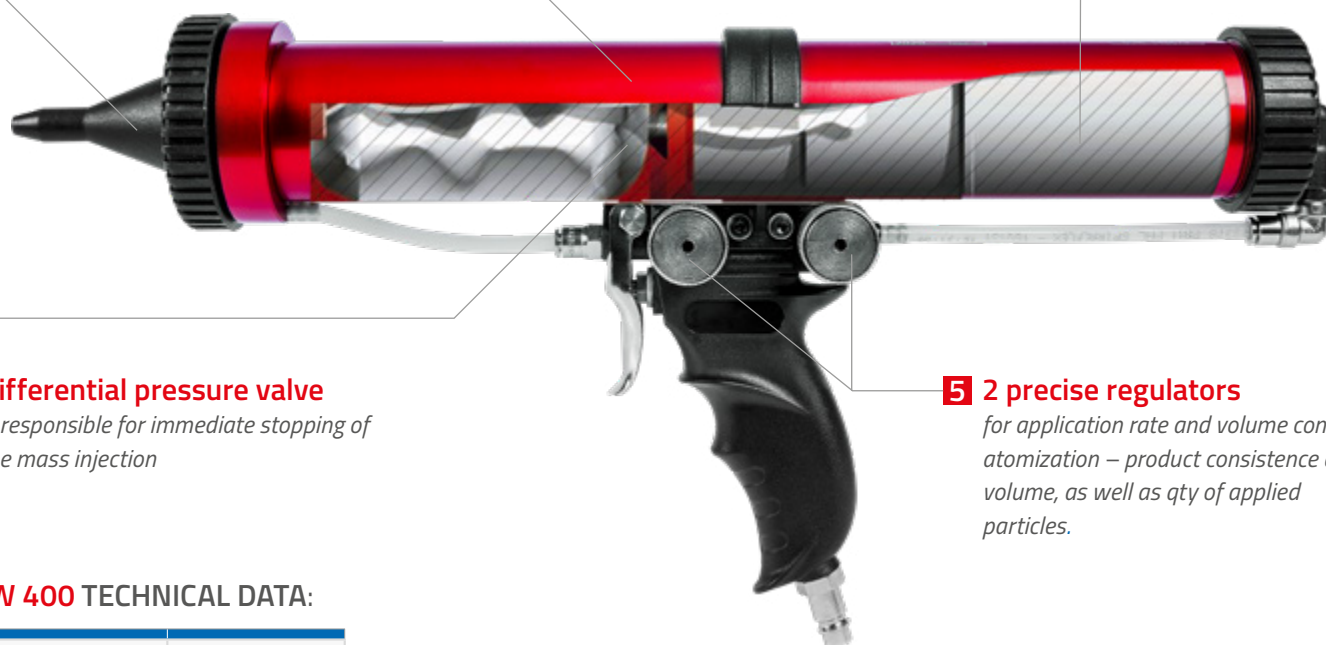

PWW 400 TECHNICAL DATA:

Index	110505N
Working pressure	6-8 bar
Max. pressure	10 bar
Air consumption	220 L/min
Compressed air quick-coupling	EURO DN 7,2 standard profile
Noise level	70 dB(A)
Length	395 x 220 mm
Dia.	64 mm
Mass	1.24 kg

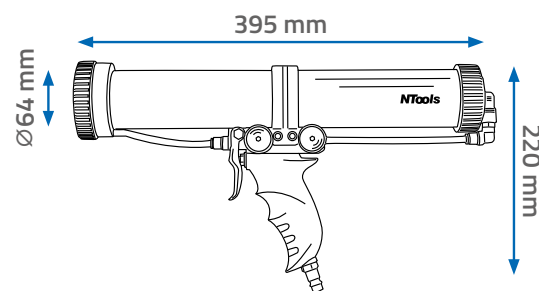

SET INCLUDES:

- 1) Pneumatic gun.
- 2) Nylon sachet sealing tip.
- 3) Sachet adapter.
- 4) Cartridge locking ring.
- 5) External short nozzle (Volkswagen type).
- 6) External long nozzle (Renault type).
- 7) Internal nozzle (cartridge dedicated).

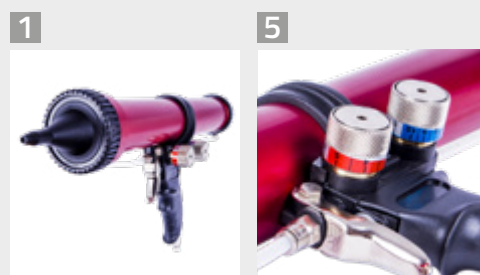

APP Sp. z o.o.

ul. Przemysłowa 10, 62-300 Września

Customer Service Department: Phone +48 61 437 00 20, bok@app.com.pl

www.APP.com.pl

20.10.2023







NTools PWW 400

Pneumatic cartridge gun with a telescopic piston for 290ml and 310ml cartridges and 400ml sachets

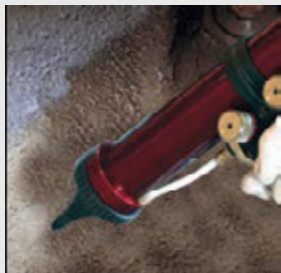
Use & Advantages:

NTools

Manufacture of motor vehicles	Body & paint shops	Woodworking shops and furniture manufacture	Building and renovation works	Works that require sealing
				



ADVANTAGES

+ MULTI-PURPOSE USE high quality pneumatic spraying gun for professionals dedicated for sealing compounds, provided with piston.	+ PRECISION provided with telescopic piston and high precision regulators for application and volume control to deliver a desired texture and uniformed application of product.
+ SAFETY VALVE that prevents an excessive flow of product.	+ "SIMPLE" CONSTRUCTION easy and quick dismantling for tool cleaning and maintenance. Dismantling of each part is possible.

APP No.	Product Description	Qty
110505N	NTOOLS PWW 400 - Pneumatic cartridge gun with a telescopic piston for 290ml and 310ml cartridges and 400ml sachets	1 item

NTools PWW 400

Pneumatic cartridge gun with a telescopic piston
for 290ml and 310ml cartridges and 400ml sachets

Nozzles suitable for NTools PWW 400:

NTools



APP No. 110505WK

NTools D
inner nozzle



APP No. 110505ZP

NTools DW
intermediate



APP No. 110505ZR

NTools DW
long



APP No. 110505ZV

NTools DW
short



APP No. 110607

APP DK 10
soft

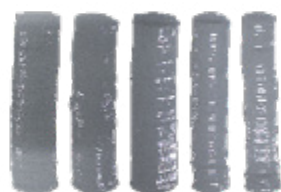

APP No. 110606

APP DK 40
hard



APP No. 110601

APP MTL 1
for a closed cartridge



APP No. 110603

APP MTL 1
for open cartridge

